

# Cabinets

Furniture for storage and workstations



# Cabinets

## Furniture for storage and workstations

Experience the timeless design of our ISO-modular cabinets and workstations. We tailor our ISO-modular cabinets to your needs. They come in various heights and can be fitted with a wide array of features and accessories, such as locks and telescopic pull-out trays.

### Top 5 features

- Rounded edge strip for better protection
- Doors can be delivered with glass, which allow a quick overview of the contents
- Telescopic runners with 110% pull-out grant easy access to the contents.
- The hinges allow the doors to open 270°
- Quiet, magnetic lock



*Cleanline Cabinets  
for safe and efficient  
storage*

## Cleanline cabinets

Experience the timeless design of our ISO-modular cabinets

The minimalistic, modern style of our Cleanline cabinets gives a visual calmness to the surrounding environment. The design is timeless, and they can be tailored to guarantee a perfect fit for any room. This gives you the ability to let them blend in perfectly with the building, or pre-existing furniture arrangements.

The CleanLine series can be easily recognised by the laminated doors, with soft rounded edges and the vertical handle in anodised aluminium.

Behind this calm appearance hides the potential for a highly efficient and organized interior. Each cabinet can be arranged and re-arranged with our ISO-modular baskets, shelves, trays, and other accessories, so that everything has its place.





*40/60 modular drawers with 110% pull out on telescopic runners*



*Instrument cabinets combined with drawer cabinets*

# Cleanline cabinets – features

## Front options

---



### Open front

An open front allows easy access to the cabinet's contents.



### Door

The doors are made from 16 mm chipboard faced with 0.7 mm high-pressure laminate.



### Glass door

Hardened glass fitted in a solid frame without joints.



### Roller front

A roller front is the ideal solution for rooms where there is limited space for opening doors.



### Drawer cabinets

Drawer cabinets are practical for storing smaller items, and we have many different sizes to match your needs. All drawer cabinets are delivered with soft-close as standard.



### Drawers

We offer two types of drawers:

1. Pull-out drawers for modules with full pull-out, soft-close. These are designed for our standard 40/60 trays and baskets.
2. Drawers with melamine bottom and steel side panels; also with full pull-out, soft-close a full-stop.

# Cabinet Specifications

---

## Standard cabinet modules

The sides, top, and bottom of the cabinets are made from 19 mm chipboard, faced with melamine (110 g/m<sup>2</sup>) on both sides and fitted with a 6 mm back panel. All edges are provided with 1 mm ABS plastic profiles. The front edges have an integrated dust seal, with beading for cabinets with doors, and without beading for open front cabinets.

## Infill panels

The infill panels ensure a perfect fit when the cabinets are installed. They are made from 19 mm chipboard faced on both sides with melamine.

The infill panels can be provided with a front panel, high pressure laminated in the same colour as the cabinet door.



### Hinges

The unique hinge is made from anodised aluminium. The hinge is provided with plain bushings, which minimises wear and is optimal for many years of daily use. The opening angle is 270 degrees.



### Edge strip

The rounded grey plastic edge strip protects the laminate from blows.



### Magnetic lock

The lock system is equipped with a nylon magnetic lock as standard.



### Doors & drawer fronts

CleanLine doors and drawer fronts are characterised by their rounded corners. They are made from 16 mm chipboard faced with 0.7 mm high-pressure laminate on both sides.

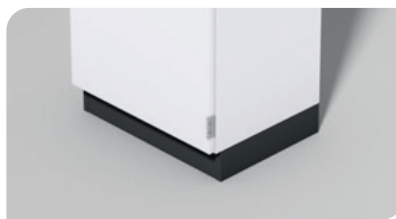

### Plinth

The plinths are made of 18 mm water resistant plywood with 0.7 mm laminate, in the colour F2297 Terril, dark grey. The plinths are delivered with levelling feet as standard. If a shared plinth is required, this is delivered without levelling feet.



### Handles

The 160 mm vertical anodised aluminium handle completes the exclusive CleanLine design.

# Cleanline cabinets



## Drawers

Drawers have side panels made of powder painted steel and can be fully pulled out. Drawer bottoms and backpieces are made of 16 mm melamine, and all visible edges are provided with bonded polypropylene edge strips.

Drawer runners are fitted using Euro screws. The drawers can be removed, have inbuilt stop and bear loads up to 30 kg. The drawer sides match the height of the fronts. Drawers for modules are also available with full pull-out and soft-close.

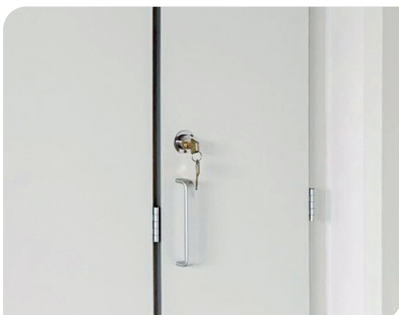

## Underbench cabinets with castors

Underbench cabinets with castors are called mobile units. The height of these mobile units is 88 mm, and the front castors are fitted with brakes.

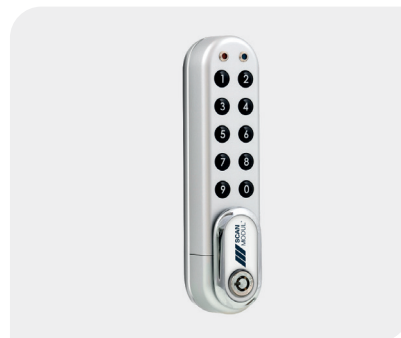

## Locks

The majority of the cabinet models can be fitted with different lock types. The most popular option is a lock that works with a numeric code, but we offer locks with keys as well.





40/60 modular tall cabinets in combination with a wardrobe cabinet



*40/60 modular tall cabinets  
with glass doors*



*40/60 modular wall  
cabinets with glass doors*



*40/60 modular cabinets in combination  
with a worktable*

# Cleanline cabinets

## Dimensions

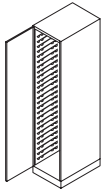
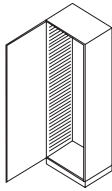
	Width	Depth	External Dimensions	
<b>a</b> 	457 cm	650 cm	Tall incl. plinth	2100 mm
			Tall for wall mount	1826 mm
			Tall wall cabinet	1195 mm
			Wall cabinet	650 mm
			Top cabinet	581 mm
			Under cabinet incl. plinth	905 mm
			Under cabinet for hanging	581 mm
				389 mm
			Drawer cabinet for hanging	171 mm
	140 mm			
<b>b</b> 	657 cm	450 cm	Tall incl. plinth	2100 mm
			Tall for wall mount	1826 mm
			Tall wall cabinet	1195 mm
			Wall cabinet	650 mm
			Top cabinet	581 mm
			Under cabinet incl. plinth	905 mm
			Under cabinet for hanging	581 mm
				389 mm
			Drawer cabinet for hanging	171 mm
	140 mm			

## Standard colour chart for cabinets

### Basic



ASD1048B  
WHITE CAMELIA



F2791  
SILVER

### Price cat. 1



F2255  
POLAR WHITE

### Price cat. 2



F7880  
THISTLE X



F7927  
FOLKSTONE



F7884  
CHINA BLUE



K1019  
AZUR



F7879  
DUSTY JADE



K1997  
OCEANO



F7912  
STORM



A0673  
BLU VIOLETTO



# Cleanline cabinets

## Cabinet fittings

The various options with which our cabinets' side panels can be fitted.

- VarioTilt side panels provide flexible storage based on the ISO storage systems with 40 x 60 cm trays and baskets
- Telescopic runners, when you need drawers with easy access
- Regular shelves for basic storage needs

We also offer solutions with a combination of these options.

Many of the cabinets in the product overview already include cabinet side panels or telescopic runners, but, if you wish to buy these separately, they are listed at the end of the product overview in this chapter.



### Variotilt cabinet side panels

Injection moulded cabinet side panel for horizontal inserts.

This side panel allows the trays to be pulled out and tilted downwards, to provide easier access to its contents.

They are fitted with a build-in stop function and can be fitted with removable load relief wheels at the front edge of the panel, which make it easier to pull out trays that hold heavy products.

Injection moulding is more durable than the traditional vacuum moulded version. The maximum load is 20 kg per insert.



### Telescopic runners

Stainless steel telescopic runners, fitted on perforated rails.

The perforated rails can be adjusted to 25 mm spacing. This solution is recommended for the storage of heavy products, for which 110 % pull-out is required. These are often fitted in cabinets, from the working height down to the floor.

Our trays and baskets can be placed directly on the telescopic runners without any need for additional tools.

The maximum load is 50 kg per insert. Many of the cabinets in the product overview already include cabinet side panels or telescopic runners, but can be purchased separately.

## Laminate worktop

Length	Depth	Depth	Depth
600 mm	450 mm	600 mm	650 mm
900 mm			
1200 mm			
1800 mm			
2100 mm			
2400 mm			
2700 mm			
3000 mm			

Table top with post-shaped front edge, straight back edge



Table top with 4 straight edges



Table top with upstand on the back



## Accessories worktops

Description	Height	Depth	Item no.
Worktop bracket		300 mm	7313030
		400 mm	7313040
Worktop bracket, lacquered	300 mm	550 mm	7313055
		560 mm	7313056
Supports, epoxy lacquered	500 mm	760 mm	7313076
		560 mm	7313090
Supports ready for shelves, epoxy lacquered	500 mm	560 mm	7313090
Installation bracket, epoxy lacquered	30 mm	560 mm	SAB50

## Shelves

Description	Length	Width	Height	Item no.
Compact laminate panel	300 mm	400 mm	6 mm	2234400
	400 mm	600 mm	6 mm	2264400
Melamine panel, white	300 mm	400 mm	12 mm	2234403
	400 mm	600 mm	12 mm	2264403

## Resistance chart for worktops

	Organic solvents	Acid / alkali	Heat resistant	Deformation	Impact resistance	Discolouration	Surface smoothness	Absorption
Laminate	•	•	•	•	•	•	••	••
Compact laminate	••	•	•	••	••	••	•••	••
Polypropylene	•••	•••	•	•	•	•	•••	••
Stainless steel 316/304	•••	•••/••	•••	••	•••	•••	•••	•••
Epoxy Resin	•••	•••	••	•••	••	•••	•••	•••
Composite	•••	•••	•••	•••	•••	•••	•••	•••
Ceramic	•••	•••	•••	•••	••	•••	•••	••

Excellent •••    Good ••    Acceptable •

# Fire-retardant/lead protected cabinets

Fire-retardant/ lead protected cabinets/pass-through cabinets are used in corridors between the corridor and rooms, for example, cleaning rooms, wards, operating theatres, medicine rooms etc.

## Approval

According to the Fire Resistance Assessment – from the Danish Institute of Fire and Security Technology – 17.06.2004, the cabinets comply with the requirements in DS 1051.2 for a BD pass-through cabinet 30 (test report B 17640 b). The doors have Danish Standard certification license number 671E. The relevant assessment is available. It should be noted that the responsible local fire authority should always be contacted for final approval before commissioning.

## Technical specification

The cabinet/pass-through cabinet comprises a standard cabinet/pass-through cabinet, where one cabinet door is replaced by a single-leaf door – panel thickness 40 mm. On the outside of the door leaf, a 19 mm Cleanline cabinet door is affixed. The fire doors are fitted with a vertical door handle latch, which is activated by turning the handle.

If the cabinet is to be delivered without plinth, a moulding on the outer door and a steel moulding, which is milled in, and fastened to, the floor, are enclosed. The joints between pass-through cabinets and adjoining building elements are filled with stone wool, which is enclosed.

## Lead protection

When the cabinet is installed between a corridor and an operating theatre, normally the cabinet needs to be lead protected. This is to avoid any radiation penetrating the cabinet from the operating room to people in the corridor. This is done by including 2 mm lead in the door and the frame around the door. In addition to this, additional lead is installed between frame of the door and wall, connecting the lead protection within the wall, with the cabinet.

Whether you need a fire-retardant cabinet, a lead protected cabinet or a combination, the outside measurements of the pass-through cabinet, are the same.



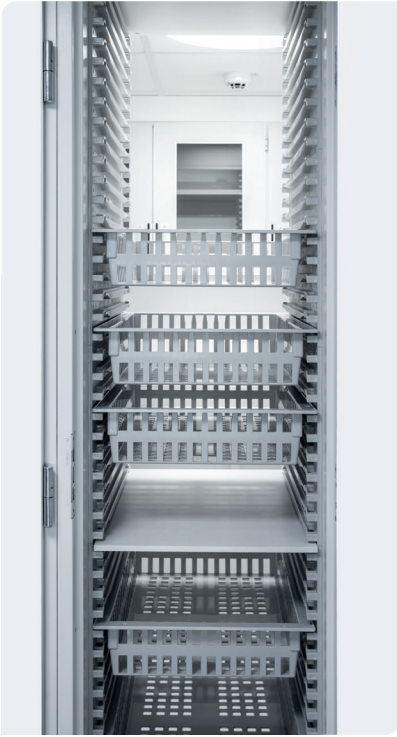

*40/60 modular pass-through cabinet*



*40/60 modular lead and fire protected pass-through cabinets, seen from the outside of the OR room*



*40/60 modular pass-through cabinets seen from the side of the OR room*

# Fire-retardant/lead protected cabinets

## Cabinet

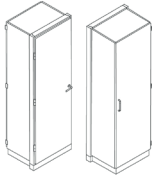
Cabinet	Description	Width	Depth	Height	Item no.
	Without plinth, fire-retardant	694 mm	525 mm	1864 mm	12069186528521-31/-41
	Without plinth, fire-retardant	494 mm	725 mm		12049186728521-31/-41
	Without plinth, fire-retardant	694 mm	525 mm	2038 mm	12069203528521-31/-41
	Without plinth, fire-retardant	494 mm	725 mm		12049203728521-31/-41

## Pass-through cabinet

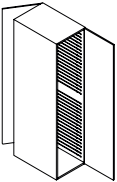
Pass-through cabinet	Description	Width	Depth	Height	Item no.
	Without plinth, fire-retardant	694 mm	545 mm	1864 mm	12069186548521-31/-41
	Without plinth, fire-retardant	494 mm	745 mm		12049186748521-31/-41
	Without plinth, fire-retardant	694 mm	545 mm	2038 mm	12069203548521-31/-41
	Without plinth, fire-retardant	494 mm	745 mm		12049203748521-31/-41
	Without plinth, fire-retardant and lead protected	694 mm	545 mm	1864 mm	12069186548721 31/41
	Without plinth, fire-retardant and lead protected	494 mm	745 mm		12049186748721 31/41
	Without plinth, fire-retardant and lead protected	694 mm	545 mm	2038 mm	12069203548721 31/41
	Without plinth, fire-retardant and lead protected	494 mm	745 mm		12049203748721 31/41

## Cabinet dimensions

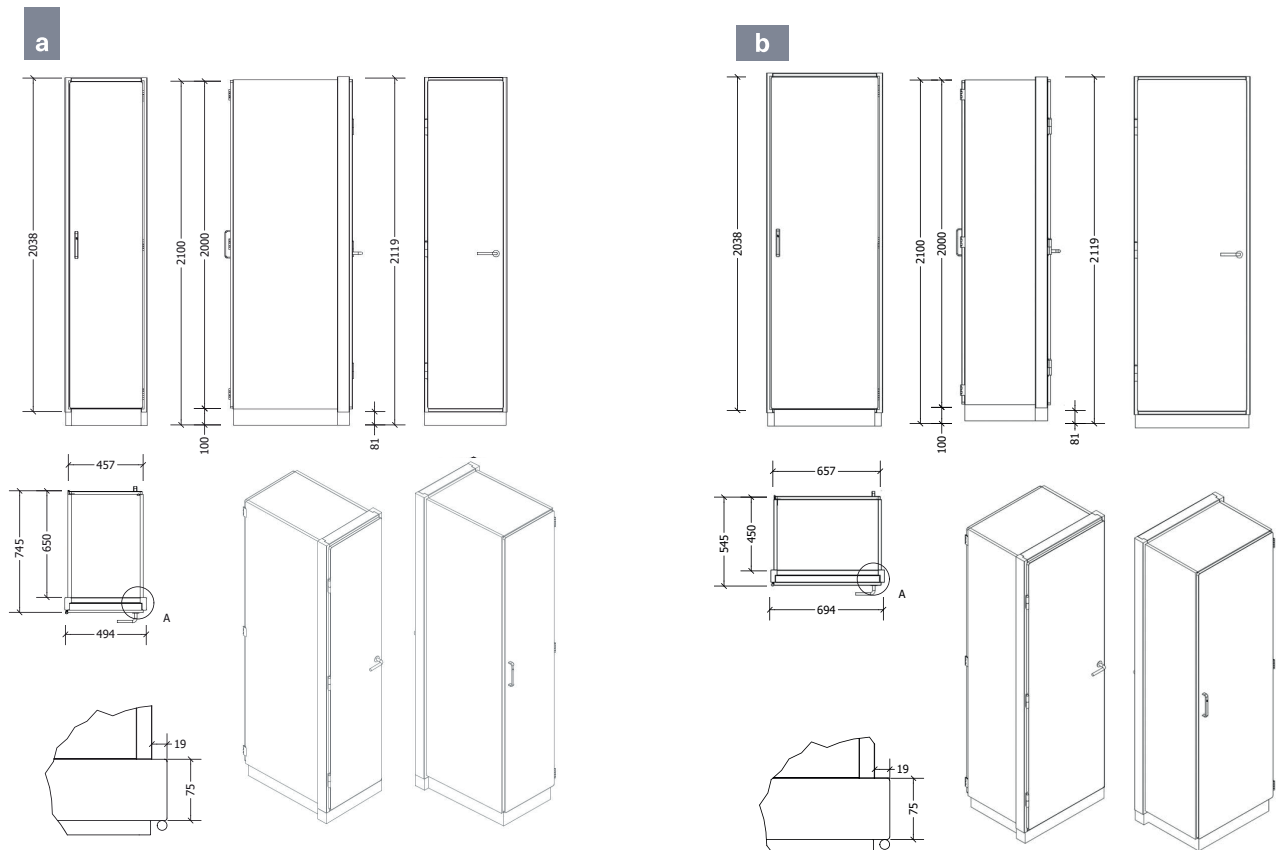

# Mechanical interlock system

ScanModul®'s cabinet range for the hospital sector consists of tall cabinets for both wall mounting and as pass-through cabinets.

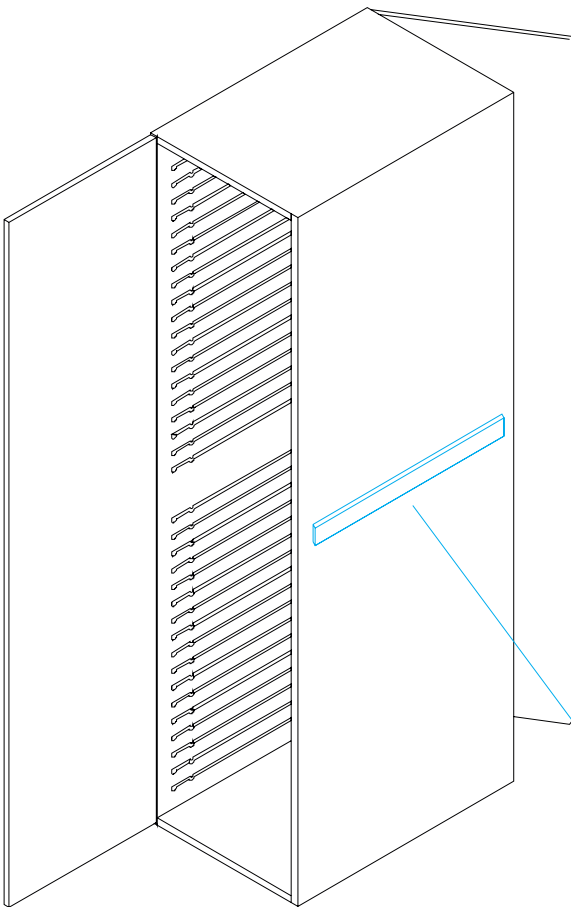

## Safe handling with lock system

The interlock is designed for cabinets with access from both sides, where the mechanical locking system ensures that the cabinet only can open from one side at a time.

The locking system works without connection of electricity and is based on a single mechanical principle with few moving parts, giving a very stable and secure function.

**The interlock system has been tested with 500.000 openings.**



a

b

### Interlock mechanical

Description	Item no.
A-Type for cabinets with depth 630 mm	107321914
B-Type for cabinets with depth 430 mm	107321915

# Instrument cabinets

## Tall cabinets

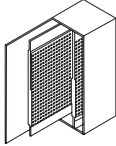
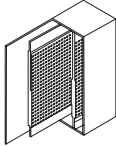
Tall cabinet with standard door	Description	Width	Depth	Pull-out	Hinges	Item no
	Instrument cabinets with standard door, 1 to 2 pull-outs with perforated panel for instrument hooks. Height 2100 mm, with plinth	457 mm	650 mm	1	Right / Left	12045210650117-31/-41
		657 mm	450 mm	2	Right / Left	12065210450117-31/-41
Tall cabinet with glass door	Description	Width	Depth	Pull-out	Hinges	Item no
	Instrument cabinets with glass door, 1 to 2 pull-outs with perforated panel for instrument hooks. Height 2100 mm, with plinth	457 mm	650 mm	1	Right / Left	12045210650117-34/-44
		657 mm	450 mm	2	Right / Left	12065210450117-34/-44

## Wall cabinets

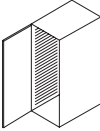
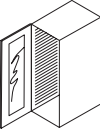
Wall cabinet with standard door	Description	Width	Depth	Pull-out	Hinges	Item no
	Instrument cabinets with standard door, 1 to 2 pull-outs with perforated panel for instrument hooks. Height 1195 mm	457 mm	650 mm	1	Right / Left	12045119658367-31/-41
		657 mm	450 mm	2	Right / Left	12065119458367-31/-41
Wall cabinet with glass door	Description	Width	Depth	Pull-out	Hinges	Item no
	Instrument cabinets with glass door, 1 to 2 pull-outs with perforated panel for instrument hooks. Height 1195 mm	457 mm	650 mm	1	Right / Left	12045119658367-34/-44
		657 mm	450 mm	2	Right / Left	12065119458367-34/-44



*Perforated panel for instruments in epoxy coated steel, mounted on a 110% telescopic pull-out*



*Stainless steel instrument hooks.*



*40/60 modular tall cabinets build-in the wall*



*40/60 modular tall cabinets with baskets and tilt function*



*Tall CleanLine cabinets  
with angled top*



*Cabinets for storage of consumables and instruments*

## Medicine cabinets

The ScanModul® medicine cabinet is a very good alternative, when an institution / clinic does not have a separate and lockable medication room. The medicine cabinet can be delivered with and without an extra lockable drug box inside.



*Wall hung  
medication cabinet*





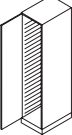
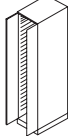
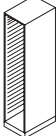
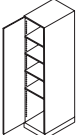
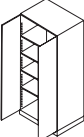
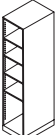
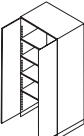
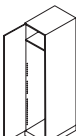

# Tall cabinets – product overview

## Tall cabinets – H 2100 mm, incl. 100 mm plinth

Description	Width	Depth	Item no.
 <p>Tall cabinet, 1 door, incl. VarioTilt™ and 100 mm plinth (Also available with glass door)</p>	357 mm	450 mm	1203521045011131 /41*
	457 mm	650 mm	1204521065011131 /41*
	657 mm	450 mm	1206521045011131 /41*
 <p>Tall cabinet, double door, incl. VarioTilt™ and 100 mm plinth (Also available with glass door)</p>	657 mm	450 mm	1206521045011151
 <p>Tall cabinet, no door, incl. VarioTilt™ and 100 mm plinth</p>	357 mm	450 mm	1203521043011101
	457 mm	650 mm	1204521063011101
	657 mm	450 mm	1206521043011101
 <p>Tall cabinet, 1 door, incl. 4 shelves and 100 mm plinth (Also available with glass door)</p>	457 mm	650 mm	1204521065011431 /41*
	657 mm	450 mm	1206521045011431 /41*
	457 mm	450 mm	1204521045011431 /41*
	657 mm	650 mm	1206521065011431 /41*
 <p>Tall cabinet, double door, incl. 4 shelves and 100 mm plinth (Also available with glass door)</p>	914 mm	450 mm	1209121045011451
	914 mm	650 mm	1209121065011451
 <p>Tall cabinet, no door, incl. 4 shelves and 100 mm plinth</p>	457 mm	630 mm	1204521063011401
	657 mm	430 mm	1206521043011401
 <p>Parking cabinet, double door, incl. 3 shelves at the top and U plinth</p>	914 mm	450 mm	1209121045441551
	914 mm	650 mm	1209121065441551
 <p>Wardrobe, 1 door, incl. hanging rail and 1 shelf and 100 mm plinth</p>	357 mm	650 mm	1203521065031531 /41*
	457 mm	650 mm	1204521065031531 /41*

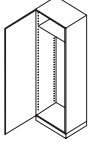
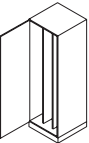
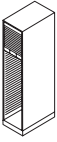
\* All items ending with -31 are right hinged, all items ending with -41 are left hinged.

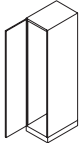
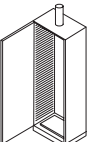
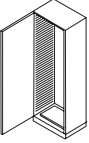
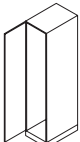
	Description	Width	Depth	Item no.
	Wardrobe, 1 door incl. pull-out rail and 1 shelf and 100 mm plinth	657 mm	450 mm	1206521045031531 /41*
		457 mm	650 mm	1204521065611731 /41*
	Scope cabinet, 1 door incl. 1 pull-out panel (B 457) incl. 2 pull-out panels (B 657) (exc. hangers for scopes) incl. 100 mm plinth	657 mm	450 mm	1206521045611731 /41*
		657 mm	650 mm	1206521065611731 /41*
	Tall cabinet with roller front incl. VarioTilt™ and 100 mm plinth	457 mm	680 mm	120452106801121
		657 mm	480 mm	120652104801121
	Tall cabinet, no door, modular sides for fitting other cabinet side panels incl. 100 mm plinth	457 mm	630 mm	1204521063011501
		657 mm	430 mm	1206521043011501
	Fire retardant cabinet, 1 door, incl. VarioTilt™ BD30 on door, incl. frame (H 2038 mm - item no. is excl. plinth)	494 mm	725 mm	1204920372852131 /41*
		694 mm	525 mm	1206920352852131 /41*
	Bedpan/storage cabinet, unclean, 1 door incl. VarioTilt™ with 100 mm studs for oven with air gap in the bottom	657 mm	450 mm	1206521045151131 /41*
	Bedpan/storage cabinet, clean, 1 door incl. VarioTilt™ with Telco oven	657 mm	450 mm	1206521045161131 /41*
	Tall cabinet, 1 door, modular sides for fitting other cabinet side panels incl. 100 mm plinth (Also available with glass door)	457 mm	650 mm	1204521065011531 /41*
		657 mm	450 mm	1206521045011531 /41*

# Tall cabinets – product overview

## Tall cabinets – H 2100 mm

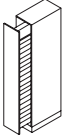
Description	Width	Depth	Item no.
 <p>Medicine cabinet with pull-out front 10 (W257) or 20 (W357) medicine trays (Exc. partitions for trays)</p>	257 mm	650 mm	1202521065011761
	357 mm	650 mm	1203521065011761

## Tall cabinets – H 2100 mm pass-through

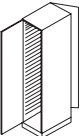
Description	Width	Depth	Item no.
 <p>Pass-through cabinet, incl. VarioTilt™ and 100 mm plinth (Also available with glass doors)</p>	457 mm	670 mm	1204521067011151
	657 mm	470 mm	1206521047011151

## Tall cabinets – H 2038 mm pass-through

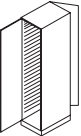
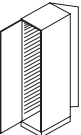
Description	Width	Depth	Item no.
 <p>Fire retardant pass-through cabinet with 2 mm lead lining BD30 and lead lining on 1 door incl. BD30 frame incl. VarioTilt™ (H 2038 mm – item no. is excl. plinth)</p>	494 mm	745 mm	1204920374872131/41a
	694 mm	545 mm	1206920354872131/41
 <p>Fire retardant pass-through cabinet BD30 on 1 door Incl. BD30 frame Incl. VarioTilt™ (H 2038 mm – item no. is excl. plinth)</p>	494 mm	745 mm	1204920374852131 /41*
	694 mm	545 mm	1206920354852131 /41*

\* All items ending with -31 are right hinged, all items ending with -41 are left hinged.

## Tall cabinets – H 1826 mm for wall mounting

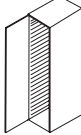
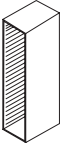
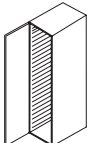
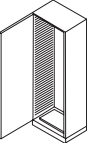
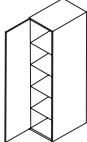
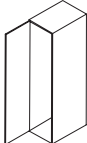
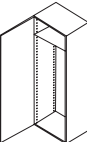
Description	Width	Depth	Item no.
	457 mm	650 mm	1204518265012131 /41*
	657 mm	450 mm	1206518245012131 /41*
Tall cabinet, 1 door, incl. VarioTilt™ (Also available with glass door)	457 mm	630 mm	1204518263012101
	657 mm	430 mm	1206518243012101
	494 mm	725 mm	1204918672852131 /41*
	694 mm	525 mm	1206918652852131 /41*
Fire retardant cabinet, 1 door, incl. VarioTilt™ BD30 on door, incl. BD30 frame (H 1864 mm)	657 mm	450 mm	1206518245152131 /41*
		657 mm	450 mm
Bedpan/storage cabinet, unclean, 1 door with 100 mm studs for oven with air gap in the bottom, incl. VarioTilt™		457 mm	650 mm
	657 mm	450 mm	1206518245012431 /41*
	457 mm	650 mm	1204518265012531 /41*
	657 mm	450 mm	1206518245012531 /41*
Bedpan/storage cabinet, clean, 1 door with Telco oven, incl. VarioTilt™	657 mm	650 mm	1206518265032531 /41*
	657 mm	450 mm	1206518245032531 /41*
	457 mm	650 mm	1204518265012531 /41*
	657 mm	450 mm	1206518245012531 /41*
Tall cabinet, 1 door, modular sides for fitting other cabinet side panels (Also available with glass door)	657 mm	650 mm	1206518265032531 /41*
	657 mm	450 mm	1206518245032531 /41*
	657 mm	650 mm	1206518265032531 /41*
	657 mm	450 mm	1206518245032531 /41*
	657 mm	650 mm	1206518265032531 /41*
	657 mm	450 mm	1206518245032531 /41*
Wardrobe, 1 door, incl. hanging rail and 1 shelf	657 mm	650 mm	1206518265032531 /41*
	657 mm	450 mm	1206518245032531 /41*

# Tall cabinets – product overview

Tall cabinets – H 1826 mm, built in

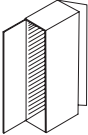
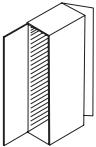
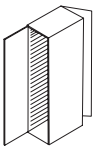
Description	Width	Depth	Item no.
 <p>Tall pass-through cabinet, incl. VarioTilt™ (Also available with glass doors)</p>	457 mm	670 mm	1204518267012151
	657 mm	470 mm	1206518247012151
 <p>Fire retardant pass-through cabinet, BD30 on door, incl. BD30 frame incl. VarioTilt™ (H 1864 mm)</p>	494 mm	748 mm	1204918674852131 /41*
	694 mm	545 mm	1206918654852131 /41*
 <p>Fire retardant cabinet with 2 mm lead lining, BD30/lead lining on 1 door, incl. BD30 frame incl. VarioTilt™ (H 1864 mm)</p>	494 mm	745 mm	1204918674872131 /41*
	694 mm	545 mm	1206918654872131 /41*



\* All items ending with -31 are right hinged, all items ending with -41 are left hinged.

# Wall cabinets – product overview

## Wall cabinets – H 1195 mm

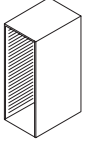
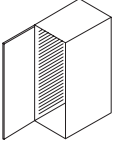
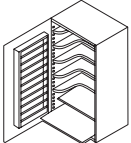
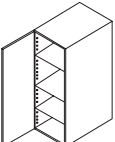
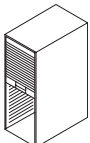
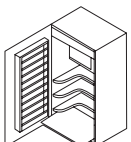
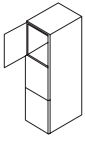
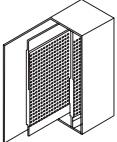
	Description	Width	Depth	Item no.
	Wall cabinet, no door, incl. VarioTilt™	357 mm	430 mm	1203511943016101
		657 mm	430 mm	1206511943016101
		457 mm	630 mm	1204511963016101
	Wall cabinet, 1 door, incl. VarioTilt™ (also available with glass door)	357 mm	450 mm	1203511945016131 /41*
		457 mm	650 mm	1204511965016131 /41*
		657 mm	450 mm	1206511945016131 /41*
	Medicine cabinet, 1 door incl. 5 indented shelves, 1 straight shelf, 1 pull-out shelf, medicine rack, light	657 mm	450 mm	1206511945056331 /41*
	Wall cabinet, 1 door, 3 shelves (Also available with glass door)	457 mm	650 mm	1204511965016431 /41*
		657 mm	450 mm	1206511945016431 /41*
	Wall cabinet with roller front, incl. VarioTilt™	457 mm	680 mm	1204511968016121
		657 mm	480 mm	1206511948016121
	Medicine cabinet, 1 door incl. 3 indented shelves, poison box with lock, 1 straight shelf, 1 pull-out shelf, medicine rack, light	657 mm	450 mm	1206511945066331 /41*
	Bag cabinet/personal locker with 3 or 6 doors (Also available with glass door)	332 mm	450 mm	1203311945426535 /45
		657 mm	450 mm	1206511945426555
	Instrument cabinet, 1 door incl. 1 pull-out with perforated panel (W457) incl. 2 pull-outs with perforated panels (W657)	457 mm	650 mm	1204511965836731 /41*
		657 mm	450 mm	1206511945836731 /41*

# Wall cabinets – product overview

## Wall cabinets – H 650 mm

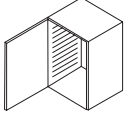
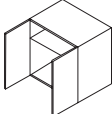
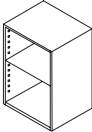
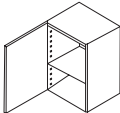
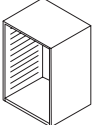
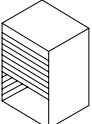
Description	Width	Depth	Item no.
 <p>Wall cabinet, 1 door, incl. VarioTilt™ (Also available with glass door)</p>	457 mm	350 mm	1204506535016131 /41*
	357 mm	450 mm	1203506545016131 /41*
	657 mm	450 mm	1206506545016131 /41*
	457 mm	650 mm	1204506565016131 /41*
 <p>Wall cabinet, double door, incl. 1 shelf (Also available with glass door)</p>	914 mm	350 mm	1209106535016451
	914 mm	450 mm	1209106545016451
 <p>Wall cabinet, no door, incl. 1 shelf</p>	457 mm	330 mm	1204506533016401
	657 mm	330 mm	1206506533016401
	657 mm	430 mm	1206506543016401
 <p>Wall cabinet, 1 door, incl. 1 shelf (Also available with glass door)</p>	457 mm	350 mm	1204506535016431 /41*
	457 mm	450 mm	1204506545016431 /41*
	657 mm	350 mm	1206506535016431 /41*
	657 mm	450 mm	1206506545016431 /41*
 <p>Wall cabinet, no door, incl. VarioTilt™</p>	457 mm	330 mm	1204506533016101
	657 mm	430 mm	1206506543016101
 <p>Wall cabinet with roller front incl. VarioTilt™</p>	657 mm	480 mm	1206506548016121

\* All items ending with -31 are right hinged, all items ending with -41 are left hinged.



# Top cabinets – product overview

## Top cabinets – H 581 mm

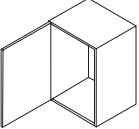
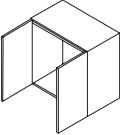
Description	Width	Depth	Item no.
 <p>Top cabinet, 1 door (For fitting above tall cabinet)</p>	457 mm	650 mm	1204505865014531 /41*
	657 mm	450 mm	1206505845014531 /41*
 <p>Top cabinet, double door (For fitting above tall cabinet)</p>	914 mm	450 mm	1209105845014551

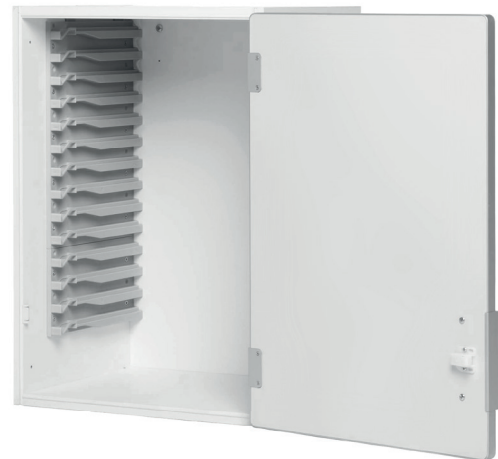

\* All items ending with -31 are right hinged, all items ending with -41 are left hinged.

# Underbench cabinets – product overview

## Underbench cabinets – H 905 mm, incl. 100 mm plinth

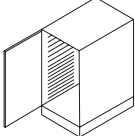
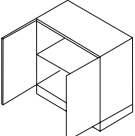
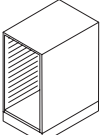
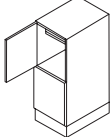
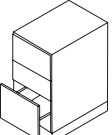
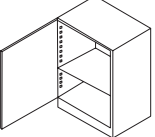
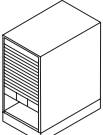
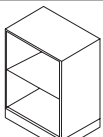
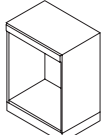
Description	Width	Depth	Item no.
 <p>Underbench cabinet, 1 door, incl. VarioTilt™ incl. 100 mm plinth</p>	357 mm	450 mm	1203509045011131 /41*
	457 mm	650 mm	1204509065011131 /41*
	657 mm	450 mm	1206509045011131 /41*
 <p>Underbench cabinet, double door, incl. 1 shelf incl. 100 mm plinth</p>	914 mm	450 mm	1209109045011451
	914 mm	650 mm	1209109065011451
	1314 mm	650 mm	1213109065011451
 <p>Underbench cabinet, no door, incl. VarioTilt™ incl. 100 mm plinth</p>	357 mm	430 mm	1203509043011101
	457 mm	630 mm	1204509063011101
	657 mm	430 mm	1206509043011101
 <p>Bag cabinet/personal locker with 2 or 4 doors incl. 100 mm plinth (Also available with mailbox)</p>	332 mm	450 mm	1203309045421535 /45
	657 mm	450 mm	1206509045421555
 <p>Drawer cabinet, 2 + 1 std. drawers incl. 100 mm plinth (Full pull-out)</p>	457 mm	650 mm	1204509065231681
	657 mm	450 mm	1206509045231681
	657 mm	650 mm	1206509065231681
 <p>Underbench cabinet, 1 door incl. 1 shelf incl. 100 mm plinth</p>	457 mm	650 mm	1204509065011431 /41*
	657 mm	450 mm	1206509045011431 /41*
	657 mm	650 mm	1206509065011431 /41*
 <p>Underbench cabinet with roller front incl. VarioTilt™ incl. 100 mm plinth</p>	457 mm	680 mm	1204509068011121
	657 mm	480 mm	1206509048011121
 <p>Underbench cabinet, no door, incl. 1 shelf incl. 100 mm plinth</p>	457 mm	630 mm	1204509063011401
	657 mm	430 mm	1206509043011401
 <p>Housing unit for fridge incl. 100 mm plinth</p>	657 mm	450 mm	1206509045111501
	657 mm	650 mm	1206509065111501

## Underbench cabinets – H 905 mm, incl. 100 mm plinth

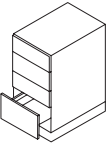
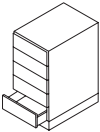
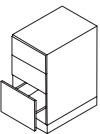
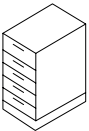
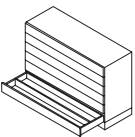
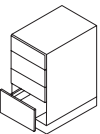
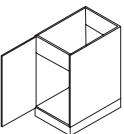
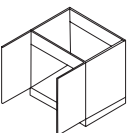
	Description	Width	Depth	Item no.
	Drawer cabinet, 3 + 1 std. drawers incl. 100 mm plinth (Full pull-out)	457 mm	350 mm	1204509045241681
		457 mm	650 mm	1204509065241681
		657 mm	450 mm	1206509045241681
		657 mm	650 mm	1206509065241681
	Drawer cabinet, 5 std. drawers incl. 100 mm plinth (Full pull-out)	457 mm	650 mm	1204509065211681
		657 mm	650 mm	1206509065211681
	Drawer cabinet, 3 pull-out frames for modules (3 x 200 mm) incl. 100 mm plinth	457 mm	650 mm	1204509065311671
		657 mm	450 mm	1206509045311671
	Drawer cabinet, 5 pull-out frames for modules (5 x 100 mm) incl. 100 mm plinth	457 mm	650 mm	1204509065211671
		657 mm	450 mm	1206509045211671
	Drawer cabinet, 5 drawers For catheters incl. fixed top panel H 126 mm incl. 5 partitions per drawer incl. 100 mm plinth	1314 mm	450 mm	1213109045211691
		1314 mm	650 mm	1213109065211691
		1371 mm	650 mm	1213709065211691
		1371 mm	650 mm	1215709065211691
	Drawer cabinet, 3 + 1 pull-out frames for modules (3 x 100 mm and 1 x 200) incl. 100 mm plinth	457 mm	650 mm	1204509065301671
		657 mm	450 mm	1206509045301671
	Sink cabinet, 1 door, incl. 100 mm plinth	457 mm	650 mm	1204509065041531 /41*
		657 mm	450 mm	1206509045041531 /41*
		657 mm	650 mm	1206509065041531 /41*
	Sink cabinet, double door, incl. 100 mm plinth	914 mm	450 mm	1209109045011451
		914 mm	650 mm	1209109065011451

\* All items ending with -31 are right hinged, all items ending with -41 are left hinged.

# Underbench cabinets for hanging

## Underbench cabinets for hanging H 581 mm

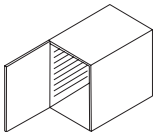
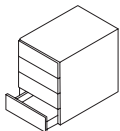
Description	Width	Depth	Item no.
 <p>Underbench cabinet, 1 door, incl. VarioTilt™</p>	457 mm	650 mm	1204505865013131 /41*
 <p>Drawer cabinet, 4 pull-out frames for modules (4 x 100 mm)</p>	657 mm	450 mm	1206505845313671
	457 mm	650 mm	1204505865313671

## Underbench cabinets for hanging H 389 mm

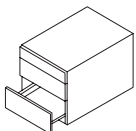
Description	Width	Depth	Item no.
 <p>Drawer cabinet, 1 + 2 pull-out frames for modules (2 x 50 and 1 x 100 mm)</p>	657 mm	450 mm	1206503845313671
	457 mm	650 mm	1204503865313671

## Drawer for hanging H 168 mm

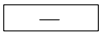
Description	Width	Depth	Item no.
 <p>Drawer unit, 1 pull-out frame for 1 x 100 mm modules</p>	657 mm	450 mm	1206501645603671
	457 mm	650 mm	1204501665603671

\* All items ending with -31 are right hinged, all items ending with -41 are left hinged.

# Cabinet side panels – product overview

## Cabinet side panels with brackets – tall cabinet parts

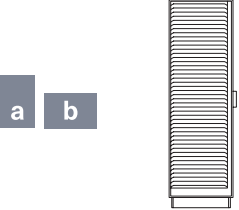
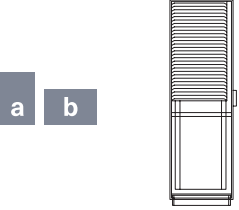
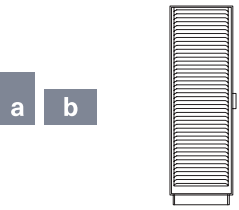
	Description	Width	Depth	Item no.
	VarioTilt (straight insert) Number of inserts: 50 Distance between inserts: 37.5 mm (1½") Type A	400 mm	600 mm	18S41977*
				18M41977*
	VarioTilt (straight insert) Number of inserts: 50 Distance between inserts: 37.5 mm (1½") Type B	600 mm	400 mm	18S61977*
				18M61977*
	VarioTilt (straight insert) - Perforated rail 1. Number of inserts: 27 Distance between inserts: 37.5 mm (1½") 2. Hole separation: 25 mm (1") Type A	400 mm	600 mm	18S41975*
				18M41975*
	Cabinet side panel (straight insert) - Perforated rail 1. Number of inserts: 27 Distance between inserts: 37.5 mm (1½") 2. Hole separation: 25 mm (1") Type B	600 mm	400 mm	18S61975*
				18M61975*
	VarioTilt (straight insert) for pass-through cabinets Number of inserts: 50 Distance between inserts: 37.5mm (1½") Type A	400 mm	600 mm	18S41977*
				18M41977*
	VarioTilt (straight insert) for pass-through cabinets Number of inserts: 50 Distance between inserts: 37.5mm (1½") Type B	600 mm	400 mm	18S61977*
				18M61977*



\* Please note:

18Sxxxx : Loose Panels, not mounted.







18Mxxxx : Panels mounted in cabinets.

# Cabinet side panels – product overview

## Cabinet side panels with brackets – underbench cabinet parts

	Description	Width	Depth	Item no.
	 VarioTilt (straight insert) Number of inserts: 20 Distance between inserts: 37.5 mm (1½") Type A	400 mm	600 mm	18S42977*
				18M42977*
	VarioTilt (straight insert) Number of inserts: 20 Distance between inserts: 37.5 mm (1½") Type B	600 mm	400 mm	18S62977*
				18M62977*

## Cabinet side panels with brackets – wall cabinet parts

	Description	Width	Depth	Item no.
	 VarioTilt (straight insert) Number of inserts: 30 Distance between inserts: 37.5 mm (1½") Type A	400 mm	600 mm	18S43907*
				18M43907*
	VarioTilt (straight insert) Number of inserts: 30 Distance between inserts: 37.5 mm (1½") Type B	600 mm	400 mm	18S63907*
				18M63907*
	 VarioTilt (straight insert) Number of inserts: 15 Distance between inserts: 37.5 mm (1½") Type D	600 mm	400 mm	18S44977*
				18M44977*
	 VarioTilt (straight insert) Number of inserts: 15 Distance between inserts: 37.5 mm (1½") Type B	600 mm	400 mm	18S64977*
				18M64977*



\* Please note:

18Sxxxx: Loose Panels, not mounted.

18Mxxxx: Panels mounted in cabinets.

# Perforated rails and telescopic runners

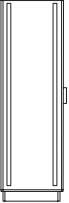
## Perforated rails

		Description	Width	Depth	Item no.
a	b		400 mm	600 mm	18S42905*
					18M42905*
			600 mm	400 mm	18S62905*
					18M62905*
		Description	Height	Item no.	
a	b		1900 mm		1864653
			1550 mm		1864654
			900 mm		1864655
			650 mm		1864657

\*Please note: 18Sxxxxx : Loose Panels, not mounted. 18Mxxxxx : Panels mounted in cabinets.

## Telescopic runners

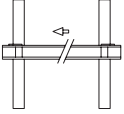
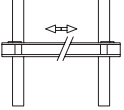
		Description	Depth	Item no.
a	b		600 mm	1867310
			400 mm	1867303
a			600 mm	1867298

## Shelves

Description	Width	Depth	Item no.
<b>Melamine shelves (12 mm) for use together with VarioTilt cabinet side panels</b>	400 mm	300 mm	2234403
	600 mm	400 mm	2264403

Cabinets without cabinet side panels with brackets are available with a number of shelves included – these are 19 mm or 22 mm thick, depending on the width of the cabinet. Contact your local sales rep, if you have use for additional shelves for these types of cabinets.

# Locks overview

## E-Locks

---



### E-Lock with key option

Description	Item No
horizontal, right side knob, colour: silver	C01ELG332



### E-Lock with key option

Description	Item No
horizontal, left side knob, colour: silver	C01ELG330



### E-Lock with key option

Description	Item No
vertical, left side knob, colour: silver	C01ELG334

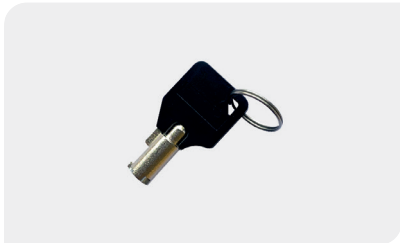

### E-Lock Master Key

Description	Item No
	C01ELG335





# Mounted items

Some of our products can also be mounted on the wall

## Wall mounted shelves

The ScanModul® wall mounted shelving system for fixing direct on walls. Epoxy painted rails guarantee high stability. The shelves are available in three types of finish: melamine, laminate or as epoxy painted steel.

## Wall mounted ScanCell® / ScanCell® on plinth:

Range of fixed or wall cabinets has been designed for sensitive areas like OR and CSSD. They are in aluminium and ABS with an PVC plinth for the fixed facilitating cleaning in the room.





*Wall mounted height adjustable shelving*

# Height-adjustable tables

Smart storage solutions to make the most of your workspace

Meet the demands of modern medicine with our smart storage solutions. Our ergonomic worktables are adjustable in height, can carry heavy loads and can be customised to ensure a perfect fit. Let's make the most of the space that you have.

## Single barrel height-adjustable table

This ergonomic worktable is specifically designed for the use of laptops. There's room between the bars and the walls, which allows space for electricity cables and sockets. The height can be adjusted within a range of 500mm, making it convenient for users of any height.

This item is available in a variety of different sizes. Please contact your sales representative for more information about the options.

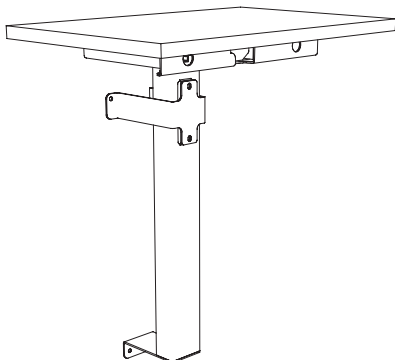

### Description

This item includes a white laminate worktop. Other sizes on request.

Colour	Depth	Width	Height range	Max. weightload	Item no.
White RAL 9016	600 mm	800 mm	690 – 1190 mm	80 kg	2620609

## Height adjustable table for desktop computers

The design of this worktable allows for convenient use of desktop computers. There's a dedicated space for the keyboard underneath the tabletop, and the lower bar gives support to the computer case. It can lift up to 80 kg's and is adjustable in height.

This item is available in a variety of different sizes. Please contact your sales representative for more information about the options.

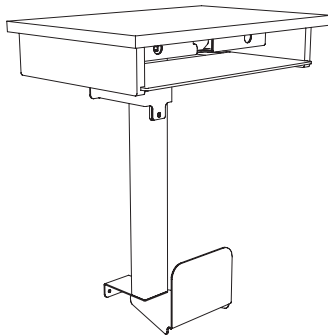

### Description

This item includes a pull-out table for a keyboard. Other sizes on request.

Colour	Depth	Width	Height range	Max. weightload	Item no.
White RAL 9016	600 mm	800 mm	690 – 1190 mm	80 kg	2620619

## Double barrel height-adjustable table

This ergonomic working table was built to support a heavier workload. With its double-barrels it can carry up to 125kg.

This item is available in a variety of different sizes. Please contact your sales representative for more information about the options.

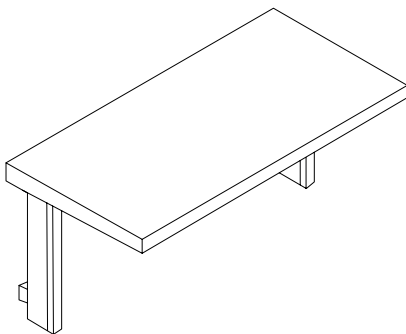

### Description

This item includes a white laminate worktop. Other sizes on request.

Colour	Depth	Width	Height range	Max. weightload	Item no.
White RAL 9016	700 mm	1200 mm	450 – 900 mm	125 kg	2620604

## Stainless steel table tops

ScanModul® delivers table tops in stainless steel in both AISI304 and AISI316 quality, depending on the usage. Table tops can be delivered included sinks if needed. As standard, table tops are delivered with a bead edge on all 4 sides. They can be installed both on top of cabinets and wall hung on stainless steel or painted brackets.





*Stainless steel table top with sink*

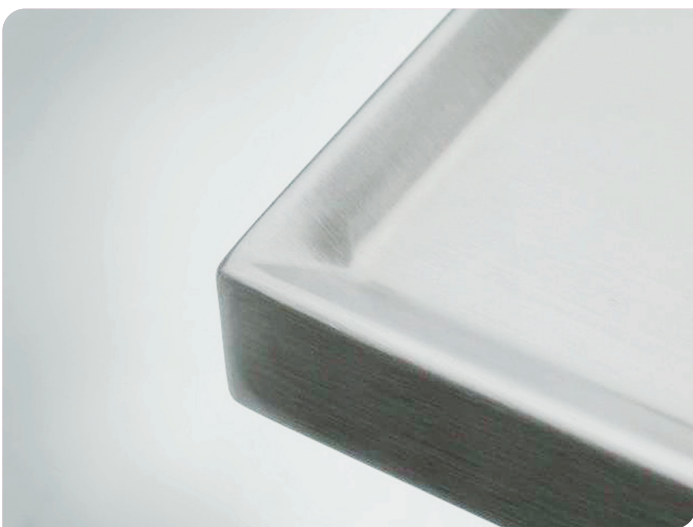

*Raised edge  
on stainless steel  
table top*